









IC 974 (LX)

double stage electronic controller with defrost



BUTTONS & LEDS

-  **UP**
Scrolls through the menu items
Increases the values
Parameter programmable
(see par. H31)
-  **DOWN**
Scrolls through the menu items
Decreases the values
Parameter programmable
(see par. H32)
-  **fnc** **fnc**
ESC function (quit)
Parameter programmable
(see par. H33)
-  **set** **set**
Accesses the set point
Accesses the Menus
Activates functions
Confirms the commands
Displays the alarms (if active)
-  **out 1** **Relays OUT 1/ OUT2**
 **out 2** ON for relay on (energized);
blinking for protection delay or
enabling blocked
-  **Alarm**
ON for active alarm; blinking for
silenced alarm that is still present.
-  **Defrost**
ON when defrosting in progress;
blinking when dripping is
in progress.
-  **LX models only**
Set/Reduced set
ON to modify Set-Point;
blinking when reduced set-point is
entered

SETTING THE SET POINT - MACHINE STATUS MENU

a) Press the 'set' button and release it to access the machine status menu.

In normal conditions, the labels for the two Set point values are found in the menu.

Once the 'SP1' label has been displayed, press the "set" button to display the Setpoint 1 value.

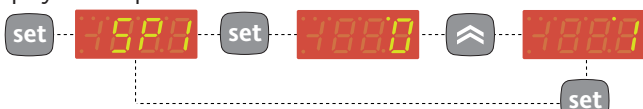

The Setpoint 1 value appears on the display. To change the Set point value, use the "UP" and "DOWN" buttons within 15 seconds. If you press the "set" button again, when the fnc button is pressed or 15 seconds elapse, the last value displayed will be stored and the "SP1" label will reappear on the display. To set the Setpoint 2 value, follow the same procedure for setting Setpoint 1.

b) If alarms are present, the "AL" label appears.



By using the "UP" and "DOWN" buttons, you can scroll through all the folders in the menu:

- AL: alarm folder (if alarms present, except for faulty probes/probe errors;
- SP1: Set point 1 setting folder.
- SP2: Set point 2 setting folder.

c) If an alarm condition exists when the Machine Status menu is accessed, the "AL" folder label appears.



(example: when maximum and minimum temperature alarms are present)

Use the UP and DOWN buttons to scroll through the list of active alarms and press 'set' to display the selected alarm.

PROGRAMMING MENU

The menu is divided into 2 levels once users have pressed the 'set' button for 5 seconds, they can access the user level folders (1)

Navigation at user level(1):



- By using the 'UP' / 'DOWN' buttons you can scroll through all the folders in the programming menu that only contain user level parameters (1)

How to access the installer level (2):



- By using the 'UP' / 'DOWN' buttons, scroll through the user level folders (1) until the folder with the "CnF" label is displayed. Then press 'set' to access the parameters contained in it.
- By using the 'UP' / 'DOWN' all the parameters in the user level (1) in 'CnF' are displayed, continue until the 'PA2' label is not longer displayed and press 'set'.
- By pressing the 'set' button next to 'PA2' the first folder containing installer level parameters will be displayed and then the 'rE1' folder.

Navigation at installer level(2):



- By using the 'UP' / 'DOWN' buttons you can scroll through all the folders in the programming menu that only contain installer level parameters (2)

How to modify the parameter value (on both levels):

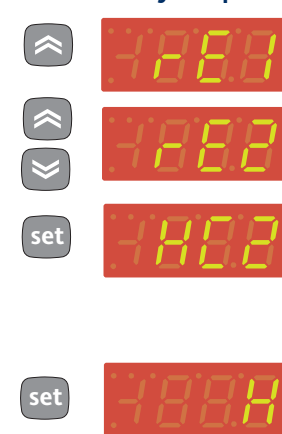

- When the 'set' button is pressed, the first folder in the menu is displayed. (e.g.: "rE1" folder)
- By using the 'UP' / 'DOWN' buttons you can scroll through all the folders in current level.
- By pressing the 'set' button next to the selected folder (in this case "rE1") the first parameter in the current level will be displayed. Select the desired parameter using the 'UP' / 'DOWN' keys.
- By pressing the 'set' button the value of the selected parameter is displayed and by using the 'UP' and 'DOWN' buttons, it can be modified

PASSWORD

Access to parameter handling both at user level and installer level can be limited by using passwords. The passwords can be enabled by setting the PA1 (user password) and PA2 (installer password) in the 'dIS' folder. The passwords are enabled if the value of the 2 parameters PA1 and PA2 is not 0.



- To access the "Programming" menu hold down the "set" button for more than 5 seconds. If specified, the user level(1) access PASSWORD will be requested



- If password 1 is enabled (not 0) you will be asked to enter it. Perform the operation by selected the correct value using the 'UP' e 'DOWN' keys and press the 'set' button to confirm.

Installer level (2) parameters

In the programming menu scroll through the folders containing the user level parameters using the UP' and 'DOWN' buttons until the CnF folder is displayed.



• Press the 'set' button to enter the 'CnF' folder where the 'PA2' label is present.



• Scroll through the folder parameters and press the 'set' button next to the 'PA2' label, '0' will appear on the display.



• Use the 'UP' / 'DOWN' buttons to select the correct value of the installer password and then press the 'set' button to access the installer level parameters (2).

If the password is not entered correctly, the device will display the 'PA2' label again and the operation will have to be repeated.

At each level in both menus, when the "fnc" button is pressed or the 15 second time out elapses, you are taken back to the higher display level and the last value on the display is stored.

COPY CARD

The Copy Card is an accessory connected to the TTL serial port used for quick programming of the unit parameters (upload and download parameter map to one or more units of the same type). upload (UL label), download (dL label) and copy card formatting (Fr label) operations are performed in the following way:



• The 'FPr' folder contains the commands necessary for use of the Copy Card. Press 'set' to access the functions.



• Use the 'UP' / 'DOWN' buttons to display the required function. Press the 'set' and uploading (or downloading) will be performed.



• If the operation is successful 'y' will be displayed, if it is not successful, 'n' will be displayed.

Download from reset

Connect the copy card when the instrument is OFF. The programming parameters are downloaded when the device is switched on. At the end of the lamp test, the following messages are displayed for about 5 seconds:

- dLY label if copy operation is successful
- dLn label if operation fails

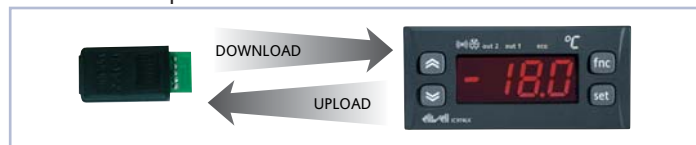

NOTE:

- after the parameters have been downloaded, the device uses the downloaded parameter map settings.
- see "FPr folder" in Parameter Table and Description of parameters

FUNCTION

The following functions are available in the FnC folder (last folder visible from the Programming Menu, level 1):

Function	Function label ACTIVE	Function label NOT ACTIVE	D.I.	Button	Active function signalling
manual defrost	dEF	dEF**	1	1	LED ON
economy set point	OSP	SP*	2	3	LED ON
controls blocked	bOn*	bOF	-	5	LED ON
heating control counter reset	rEH	rEH	6	4	LED ON
cooling control counter reset	rEC	rEC	6	4	LED ON

* indicates default

NOTE: to modify the status of a specified function press the 'set' button

NOTE: If the unit is switched off, the function labels go back to their default status.

ALARMS

LABEL ALARM	CAUSE	EFFECTS*	Resolving Problems
E1 Probe 1(control) faulty	<ul style="list-style-type: none"> • measuring of values outside the nominal reading range • control probe faulty/shorted/open probe 	"E1" label appears on display; Controller enabled as indicated by the On1 and OF1 parameters if programmed for the Duty Cycle	<ul style="list-style-type: none"> • check the probe wiring • replace the probe
AH1 High temperature alarm	• value read by probe 1 > HAL after time equal to "tAO". (see "MIN MAX ALARMS" and description of "HAL", "Att" and "tAO" parameters)	Alarms created in the "AL" folder with the AH1/AH2 label	<ul style="list-style-type: none"> • Wait for temperature value read by probe 1 to fall below HAL • Wait for temperature
AL1 Low temperature alarm	• value read by probe 1 < LAL after time equal to "tAO". (see "MIN MAX ALARMS" and description of "LAL", "Att" and "tAO" parameters)	Alarms created in the "AL" folder with the AL1/AL2 label	<ul style="list-style-type: none"> • value read by probe 1 to go above LAL
Ad2 Defrosting timed out	• interruption of defrost due to timeout instead of 2nd probe reaching defrost end temperature.	<ul style="list-style-type: none"> • Fixed alarm LED illuminates; • Recording of label Ad2 in folder AL of machine status menu 	<ul style="list-style-type: none"> • Manual silencing by pressing button • Manual silencing by pressing button • Manual silencing of alarm relay
EA External alarm	• control of alarm from active D.I. if "H11" = 5 (see "H11" parameter)	Alarms signalled in the "AL" folder with the EA label	<ul style="list-style-type: none"> • Manual silencing of alarm relay • The LED and signal in folder AL will remain active until the door is closed
Opd Door open alarm	<ul style="list-style-type: none"> • In the event of open door and delay time tdO elapsed • Delay tdO count performed when time set by parameter dAd elapses 	<ul style="list-style-type: none"> • Signalling LED blinking • Activation of buzzer when delay time tdO has elapsed • Recording of label Opd in folder AL of machine status menu 	

* Effects common to all alarms: Alarm LED permanently on; Buzzer activated (if present); Relay enabled (if configured as alarm "H21"=3)

MAX-MIN ALARMS

Temperature expressed as an absolute value (par "Att"=0) Abs(olute)

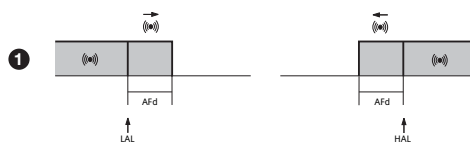

Minimum temperature alarm	Temperature lower than or equal to LAL (LAL with sign)
Maximum temperature alarm	Temperature higher than or equal to HAL (HAL with sign)
Minimum temperature alarm back swing	Temperature higher than or equal to LAL+AFd
Maximum temperature alarm back swing	Temperature lower than or equal to HAL-AFd

HEATING/COOLING INPUT DIAGRAM

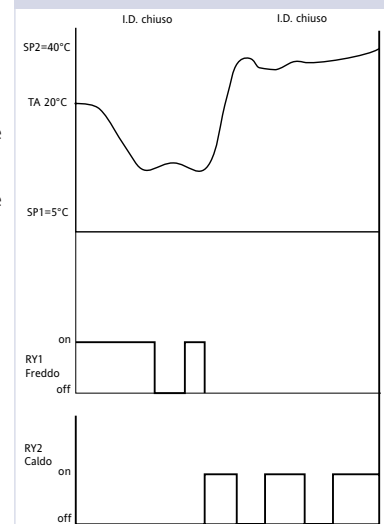

Temperature in relation to set point (par "Att"=1) rEL(ative)

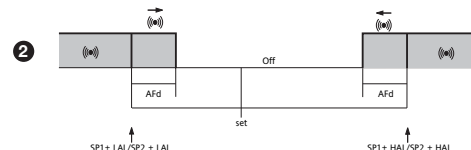

Temperature lower than or equal to set point +LAL (LAL positive only)
Temperature lower than or equal to set point +HAL (HAL positive only)
Temperature higher than or equal to set point + LAL + AFd
Temperature higher than or equal to set point - LAL +AFd
Temperature lower than or equal to set point+HAL-AFd

if Att=rEL(ative) LAL must be negative: therefore set point+LAL<set point because set point+(-|LAL|)=set-|LAL|

PARAMETER TABLE

Par.	Range	Default*	Level**	M.U.
SP1	LS1...HS1	0.0		°C/°F
SP2	LS2...HS2	0.0		°C/°F
Controller 1 - rE1 label				
HC1	H/C	H/C*	1	flag
OS1	0...30.0	0	2	°C/°F
db1	0...30.0	5.0	1	°C/°F
dF1	0.0...30.0	2	1	°C/°F
HS1	LS1...HdL	30	1	°C/°F
LS1	LdL...HS1	-50	1	°C/°F
dn1	0...250	0	1	sec
do1	0...250	0	1	min
di1	0...250	0	1	min
dE1	0...250	0	1	sec
On1	0...250	0	1	min
OF1	0...250	1	1	min
Controller 2 - rE2 label				
HC2	H/C	H/C*	1	flag
OS2	0...30.0	0	2	°C/°F
db2	0...30.0	5.0	1	°C/°F
dF2	0.0...30.0	2	1	°C/°F
HS2	LS2...HdL	30	1	°C/°F
LS2	LdL...HS2	-50	1	°C/°F
dn2	0...250	0	1	sec
do2	0...250	0	1	min
di2	0...250	0	1	min
dE2	0...250	0	1	sec
On2	0...250	0	1	min
OF2	0...250	1	1	min
Defrost - dEF label				
dtY	0/1/2	0	1	num
dit	0...250	6h	1	hh/mm/s
dt1	0/1/2	0	2	num
dt2	0/1/2	1	2	num
dCt	0/1/2	1	1	num
dOH	0...59	0	1	min
dEt	1...250	30	1	min
dSt	-50.0...150.0	8.0	1	°C/°F
dPO	n/y	n	1	flag
tcd	-31...31	0	2	min
Cod	0...60	0	2	min
Fans - FAn label				
FpT	0/1	0	2	flag
FSt	-50.0...150.0	2.0	1	°C/°F
Fot	-50.0...150.0	-50.0	0	min
FAd	1.0...50.0	2.0	2	°C/°F
Fdt	0...250	0	1	min
dt	0...250	0	0	min
dFd	n/y	y	1	flag
FCO	n/y/dc	y	1	num
Fod	n/y	n	1	flag
FdC	0...99	0	2	min
Fon	0...99	0	1	min
FoF	0...99	0	1	min
Alarms - AL label				
Att	0/1	0	2	flag
AFd	1.0...50.0	3.0	1	°C/°F
HAL(1)	LAL...150.0	50.0	1	°C/°F
LAL(1)	-50.0...HA1	-50.0	1	°C/°F
PAO	0...10	0	1	hour
dAO	0...999	0	1	min
OAO	0...10	0	0	hour
tdO	0...250	0	1	min
tAO	0...250	0	1	min
dAt	n/y	n	2	flag
AOP	0/1	1	2	flag
EAL	n/y	n	2	flag
label Add				
dEA(LX)	0...14	0	1	num
FAA(LX)	0...14	0	1	num
Display - diS label				
LOC	n/y	n	1	flag
PA1	0...250	0	1	num
PA2***	0...250	0	2	num
ndt	n/y	n	1	flag
CA1	-12.0...12.0	0	1	°C/°F
CA2	-12.0...12.0	0	1	°C/°F
CA	0/1/2	2	2	num
Display - diS label				
LdL	-55.0...302	-55.0	2	°C/°F
HdL	-55.0...302	140.0	2	°C/°F
ddl	0/1/2	1	1	num
dro	0/1	0	1	flag
ddd	0/1/2	1	2	num
rHC	0...1999	0	1	hour
rHH	0...1999	0	1	hour
Configuration - CnF label				
H00(2)(!)	0/1	0/1	1	flag
H01	0/1/2	0	2	num
H02	0...15	5	2	sec
H03	0/1/2/3	3	1	num
H10	0...250	0	2	sec
H11	-6...6	6	2	num
H14	0...250	0	2	min
H15	n/y	y	2	flag
H21(!)	0...7	1	2	num
H22(!)	0...7	3	2	num
H23(!)	0...7	2	2	num
H24(!)	0...7	4	2	num
H31(!)	0...5	1	2	num
H32(!)	0...5	0	2	num
H33(!)	0...5	0	2	num
H41	n/y	y	1	flag
H42	n/y	y	1	flag
rEL	/	/	1	/
tAb	/	/	1	/
label PA2***				
label FPr				
UL	/	/	0	/
dL	/	/	0	/
Fr	/	/	0	/

FUNCTIONS (folder with "FnC" label)The FnC folder (last folder visible from the Programming Menu) contains several functions that are activated using the "set" button

NOTE:

- (1) Refers exclusively to high and low temperature alarms
- (2) Check the NTC/PTC default probe type installed (see label (LX) in LX models
- * DEFAULT column: for parameters HC1, HC2 the default depends on the model.
- ** LEVEL column: indicates the visibility level of parameters accessed using a PASSWORD (see relevant paragraph)
- *** PA2 is visible (or will be requested, if specified) at level 1 **in the CnF folder** and can be set (modified) at level 2 **in the diS folder**

(!) WARNING!

- If one or more parameters marked with (!) are modified, the controller must be switched off after the modification and then switched back on
- **PLEASE NOTE:** We strongly recommend that you switch the instrument off and on again each time parameter configuration is changed in order to prevent malfunctioning of the configuration and/or ongoing timings.

dCt	defrost relay	dtY	regulator-cool mode relay (in defrost mode)
0= regulator-cool mode operating hours (DIGIFROST® method);	ON when dit is reached OFF when Pb2=dSt or for time (dEt)	0 = electrical defrosting; 1 = cycle reversing defrosting 2 = Free mode defrosting	OFF ON ON if requested by set point
1= equipment operating hours	ON when dit is reached OFF when Pb2=dSt or for time (dEt)	0 = electrical defrosting; 1 = cycle reversing defrosting 2 = Free mode defrosting	OFF ON ON if requested by set point
2 = regulator-cool mode stop.	ON when regulator-cool mode OFF OFF when Pb2=dSt or for time (dEt)	0 = electrical defrosting; 1 = cycle reversing defrosting 2 = Free mode defrosting	OFF NOT RECOMMENDED!!! ON if requested by set point

DESCRIPTION OF PARAMETERS

<p>SP1/2 Setpoint 1/2 The Set points can be viewed from the machine status menu and not the programming menu. The range is determined by parameters LS1/2 and HS1/2. CONTROLLER 1/2 (folders with "rE1"/"rE2" label)</p> <p>HC1/HC2 Regulating mode. If set to H, the controller operates in heating mode. If set to C, the controller operates in cooling mode.</p> <p>OS1/OS2 Offset Set point 1</p> <p>db1/db2 Regulation band 1 See ON-OFF regulation diagram</p> <p>dF1/dF2 Relay 1 intervention differential. The load will stop when Set point 1 is reached (as indicated by the control probe) and will restart at a temperature equal to Set point 1 plus (or minus depending on HC1) the value of the differential. See ON-OFF regulation diagram</p> <p>HS1/HS2 Maximum value for set point 1.</p> <p>LS1/LS2 Minimum value for set point 1.</p>	<p>dn1/dn2 Start-up delay The specified time must elapse between the controller relay start-up request and actual start-up.</p> <p>do1/do2 The specified time must elapse between shut-down of controller relay and a subsequent start-up.</p> <p>di1/di2 The specified time must elapse between two subsequent start-ups of the controller.</p> <p>dE1/dE2 The specified time must elapse between the controller relay shut-down request and actual shut-down.</p> <p>On1/On2 NOTE: for parameters dn1/2, do1/2, di1/2, dE1/2 0= not active Controller start-up time if probe is faulty. If set to "1" with Oft at "0" the controller is always on whereas if Oft >0 it operates in duty cycle mode. See Duty Cycle diagram</p> <p>OF1/OF2 Controller shut-down time if probe is faulty. If set to "1" with Oft at "0" the controller is always off whereas if Oft >0 it operates in duty cycle mode. See Duty Cycle diagram</p>	
---	--	--

DEFROST CONTROLLER (folder with “dEF” label)

dtY defrost type. Type of defrost. (see Par.dCt table)
0 = electrical defrosting;
1 = cycle reversing defrosting (hot gas);
2 = Free mode (regulator-cool mode not involved)

dit Period of time elapsing between the start of two defrosting operations.
0= function disabled (defrost is NEVER performed)

dt1 Unit of measurement for defrost times (M.U. of “dit” parameter).
0 = hours 1 = minutes 2 = seconds.

dt2 Unit of measurement for duration of defrosting (M.U. of “dEt” parameter)
0 = hours 1 = minutes 2 = seconds.

dCt defrosting time count mode.(see Par.dCt table)
0 = regulator-cool mode operating hours (DIGIFROST® method);
Defrosting active ONLY with regulator-cool mode on.
NOTE: regulator-cool mode time of operation is counted irrespective of evaporator probe (counting is active if evaporator probe is absent or faulty).
1 = equipment operating hours; defrost counting is always active when the machine is on and starts at each power-on.
2 = regulator cool-mode stop. Every time the regulator cool-mode stops a defrost cycle is performed according to the dtY parameter

dOH Start of-defrosting delay time from start-up of instrument.
-to be added to dit-

dEt Defrosting time-out; determines maximum duration of defrosting.

dSt End of defrosting temperature (determined by evaporator probe).

dPO Determines if the instrument must start defrosting at start-up (if the temperature measured by the evaporator allows this)
y = yes, starts defrost at start-up; n = no, does not start defrost at start-up.

tcd Minimum time for regulator cool-mode ON or OFF before defrost.
If >0 (positive value) the regulator cool-mode remains ACTIVE for tcd minutes; If <0 (negative value) the regulator cool-mode remains INACTIVE for tcd minutes; If =0 the parameter is ignored.

Cod Time for regulator cool-mode OFF before defrost cycle. If a defrost cycle is set within the programmed time for this parameter, the regulator-cool mode is not started up.
If =0 function is stopped.

FAN CONTROLLER (folder with “FAn” label)

FPt Characterizes the “FSt” parameter that can be expressed as an absolute temperature value or as a value related to the Set point.
0 = absolute; 1 = relative.

FSt Fan stop temperature; a value read by the evaporator probe that is higher than the set value causes the fans to stop. The value is positive or negative and, depending on the FPt parameter, could represent the temperature in absolute value or relative to Set point.

Fot Fan start temperature; if the temperature read by the evaporator is lower than the value set for this parameter, the fans remain deactivated. The value is positive or negative and, depending on the FPt parameter, could represent the temperature in absolute value or relative to Set point.

FAd Fan activation intervention differential (see par. “FSt” and “Fot”).

Fdt Fan delay time. Delay time between start-up of fan after defrosting.

dt drainage time. Dripping time.

dFd Used to select the exclusion of the evaporator fans during defrosting.
y = yes; n = no.

FCO Used to select fan stop when regulator-cool mode is switched OFF.
y = fans active (with thermostat; in response to the value read by the defrost probe, see “FSt” parameter);
n = fans off;
dc = duty cycle (using parameters “Fon” and “FoF”).

Fod Used to select the fan stop when door is open and fan re-start when door is closed (if they were active).
n=fans stop; y=fans unchanged.

FdC Fan switch off delay time after regulator cool-mode stop. In minutes. 0= function excluded

Fon Time fans are ON in duty cycle. Use of fans in duty cycle mode; valid for FCO = dc and H42=1 (probe 2 present) (evaporator))

FoF Time fans are OFF in duty cycle. Use of fans in duty cycle mode; valid for FCO = dc and H42=1 (probe 2 present) (evaporator))

ALARMS (folder with “AL” label)

Att Parameter “HAL” and “LAL” modes, as absolute temperature values or as differential compared to the Set point.
0 = absolute value; 1 = relative value.

AFd Alarm Fan differential. Alarm differential.

HAL Maximum alarm. Temperature limit (whose absolute or relative value status is regulated by “Att”) above which the alarm is activated

LAL Minimum alarm. Temperature limit (whose absolute or relative value status is regulated by “Att”). below which, the alarm is activated

PAO Power-on Alarm Override. Alarm exclusion time after instrument start-up, after a power failure

dAO Alarm exclusion time after defrost.

OAO Output (door) Alarm Override. Alarm signal delay time out door Open

tdO Time out after alarm signal following digital input disabling (door open).

tAO temperature Alarm Override. Temperature alarm signal delay time.

dAt defrost Alarm time. Alarm signal for defrost end due to time-out.
n = does not enable alarm; y = enables alarm.

AOP Alarm Output Polarity. Polarity of alarm output.
0=alarm active and output disabled; 1=alarm active and output enabled

EAL External Alarm Lock. External alarm to lock controllers
(n=does not lock, y=locks)

COMMUNICATION (folder with “Add” label)

dEA DEA= device number within the family (valid values: from 0 to 14)

FAA FAA= device family (valid values: from 0 to 14)
The value couple FAA and dEA represents the network address of the device and it is indicated in the following way: “FF.DD” (where FF=FAA and DD=dEA).

DISPLAY (folder with “dis” label)

LOC Keyboard locked (set point and buttons). However, you can still access the parameter programming menu and modify parameters including the status of this parameter to allow keyboard unlocking. y = yes; n = no.

PA1 Password 1. When enabled (value is not 0) it represents the access key to level 1 parameters.

PA2 Password 2. When enabled (value is not 0) it represents the access key to level 2 parameters.

ndt number display type. Display with decimal point. y = yes; n = no

CA1 CALibration 1. Positive or negative temperature value added to the value read by probe 1, based on “CA” parameter settings.

CA2 CALibration 2. Positive or negative temperature value added to the value read by probe 2, based on “CA” parameter settings.

CA CALibration Intervention. Intervention on view offset, thermostat control offset or both.
0 = only modifies the temperature displayed;
1 = modifies the temperature used by controllers, not the temperature displayed that remains unchanged;
2 = modifies the temperature displayed - also used by controllers.

LdL Minimum value the instrument is able to display.

HdL Maximum value the instrument is able to display.

ddl defrost display Lock. Display mode during defrosting.
0 = displays the temperature read by the thermostat control probe;
1 = locks the reading on the temperature value read by thermostat control probe when defrosting starts until the next time the Set point value is reached;
2 = displays the label “dEF” during defrosting until the next time the Set point value is reached.

dro Select °C or °F to display temperature read by probe. 0 = °C, 1 = °F. **N. B: switching from °C to °F DOES NOT modify set points, differentials, etc. (for example setpoint=10°C becomes 10°F).**

ddd Selection of the value type to be displayed.
0 = Set point; 1 = probe 1 (thermostat control);
2 = probe 2 (evaporator).

rHC Cooling operating hours counter READ ONLY PARAMETER.

rHH Heating operating hours counter READ ONLY PARAMETER.

CONFIGURATION (folder with “CnF” label)

H00 For selection of probe type, PTC or NTC.

H01 Output link. 0=independent; 1=dependent; 2=Neutral Zone (or window)

H02 Button activation time if buttons are configured for a second function. For the fnc (ESC function), UP and DOWN buttons configured for a second function (defrost, aux, etc) the time for rapid enabling is set. Aux is an exception and has a set time of 1 second

H03 Parameter that defines the relay to be deactivated if defrosting is effected 0=disabled; 1=controller 1; 2=controller 2; 3=controller 1-2

H10 Output delay from power-on. Attention! If = 0 it is not active; if >0 output will not be activated before time expires

HEATING-COOLING INPUT
If parameter H11=6 (H/C mode) machine operating can be modified, i.e.:

Input status	Machine Operating
Open	Controller 1 (cooling)
Closed	Controller 2 (heating)

With parameter H14 you can set a start-up delay and with parameter H11 you can set the polarity.

H11 Configuration of digital inputs/polarity
0 = Disabled; 1 = Defrost; 2 = Reduced set point 1 and 2;
3 = AUX; 4 = Door switch; 5 = External alarm; 6 = H/C mode;

H14 Digital input activation delay

H15 Digital input switches off loads

H21 Digital output configurability (B)
0 = Disabled; 1 = Controller 1; 2 = Controller 2;
3 = Defrost; 4 = Fans 5 = Alarm
6 = AUX 7 = buzzer

H22 Digital output configurability (A) Same as H21.

H23 Digital output configurability. (C) Same as H21.

H24 Digital output configurability. (D) Same as H21.

H31 UP button configurability.
0 = Disabled; 1 = Defrost; 2 = AUX;
3 = Att. Reduced set point; 4 = H/C Mode; 5 = Outputs shut down

H32 DOWN button configurability. Same as H31.

H33 fnc (ESC function) button configurability. Same as H31.

H41 Presence of control probe. n= not present; y= present.

H42 Presence of Evaporator probe. n= not present; y= present.

rEL Device version. Read only parameter.

tab Reserved. Read only parameter.

COPY CARD (folder with “Fpr” label)

UL UpLoad: transfer of programming parameters from instrument to Copy Card.

dL downLoad: transfer of programming parameters from Copy Card to instrument.

Fr Format. Cancels all data entered in the copy card.

PLEASE NOTE: if “Fr” parameter (formatting of copy card) is used the data entered in the card will be permanently lost. This operation cannot be undone. After the operation with the Copy Card the controller must be switched off and then switched back on

Front protection	IP65
Casing	PC+ABS UL94 V-0 resin plastic body, polycarbonate front, thermoplastic resin buttons
Dimensions	front panel 74x32 mm, depth 59 mm (terminals excluded)
Mounting	on panel, with drilling template 71x29 mm (+0.2/-0.1 mm)
Operating temperature	-5°C...55°C
Storage temperature	-30°C...85°C
Usage and storage ambient humidity	10...90% RH (non condensing)
Display range	<ul style="list-style-type: none"> • NTC probe: -50.0...110.0°C (-58...230°F); • PTC probe: -55.0...140.0°C (-67...284°F) on display 3 1/2 digits + sign
Analogue inputs	2 PTC or NTC input (parameter selectable)
Digital inputs	1 voltage-free parameter-configurable digital input
Serial	TTL for connection to Copy Card and TelevisSystem
Digital outputs (configurable)	4 outputs on relays
Buzzer output	only in certain models
Measurement range	from -55 to 140°C
Accuracy	better than 0,5% of bottom scale + 1 digit
Resolution	0,1°C (0,1°F fino a +199,9°F; 1°F above)
Consumption	1,5 W max.
Power Supply	12V~/±10%

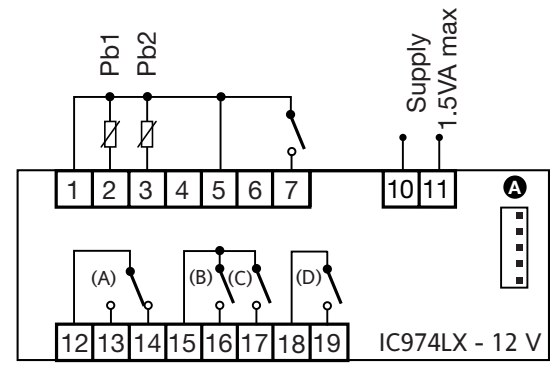

TERMINALS

1 - 2	Probe input 1 (thermostat control)
1 - 3	Probe input 2 (evaporator)
5 - 7	Digital input 1
12 - 13	N.A. relay output (A) H22 (default defrost)
12 - 14	N.C. relay output (A) H22 (default defrost)
15 - 16	N.A. relay output (B) H21 (default HEATING)
15 - 17	N.A. relay output (C) H23 (default COOLING)
18 - 19	N.A. relay output (D) H24 (default fans)
10-11	Power Supply
A	TTL Input for Copy Card and TelevisSystem*

* LX models only

NOTE: The technical characteristics in this document concerning measurements (range, accuracy, resolution, etc.) refer to the instrument in the strictest sense and not to any accessories provided such as probes, for example. This means that an error introduced by the probe is added to any error that is in the instrument.

MECHANICAL ASSEMBLY

The unit has been designed for panel-mounting: Drill a 29x71 mm hole, insert a tool and fix it in place with the brackets provided. Do not assemble the instrument in excessively humid or dirty locations since it is designed to be used in locations with normal pollution levels. Always make sure that the area next to the cooling openings of the tool is adequately ventilated.

ELECTRICAL CONNECTIONS

Warning! Always switch off machine before working on electrical connections. The instrument has screw terminals for connecting electrical cables with a maximum diameter of 2.5 mm² (only one conductor per terminal for power connections): for terminal capacity, see instrument label. The relay contacts are voltage-free. Do not exceed the maximum current allowed. For higher loads, use a suitable contactor. Make sure that the power voltage complies with the device voltage. The sensor has no connection polarity and can be extended using an ordinary bipolar cable (note that extending the probe may affect the electromagnetic compatibility (EMC) of the instrument: special care must be used when wiring). Probe cables, power supply cables and the TTL serial cable should be kept separate from power cables.

ON-OFF CONTROL DIAGRAM

HC1	HC2	H01	type of regulation
H	C	0	independent set points
H	C	1	dependent set points
-	-	2	Neutral Area (or window)

NOTE: examples with HC1=H and HC2=C

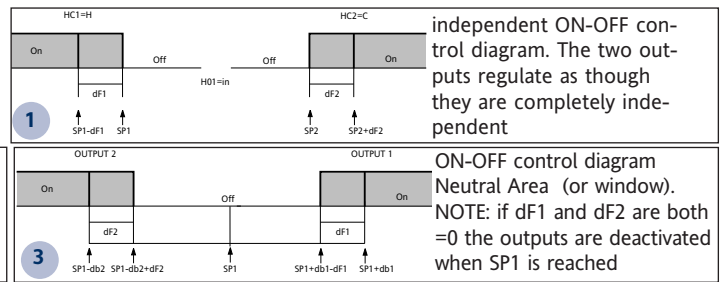
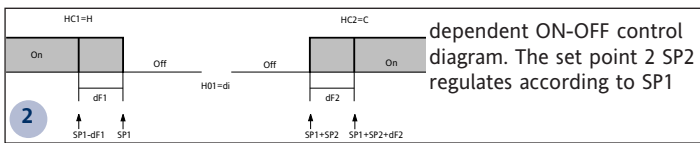

Eliwell & Controlli s.r.l.
 Via dell'Industria, 15 Zona Industriale Paludi
 32010 Pieve d'Alpago (BL) ITALY
 Telephone +39 0437 986111
 Facsimile +39 0437 989066
 Internet http://www.eliwell.it

Technical Customer Support:
 Telephone +39 0437 986300
 Email: techsuppeliwell@invensys.com

Invensys Controls Europe
 An Invensys Company
 9/2005 GB
 cod. 9IS43046



TelevisSystem

BusAdapter130/150
 TTL - RS-485 serial interface on DIN rail for connecting the device and an RS-485 network designed for connection to Televis or ModBUS supervision system.

PCInterface1110/1120
 RS-232/RS-485 serial interface for connecting a PC and a series of instruments in an RS-485 network. The device needs the BlueCard activation module supplied with the Eliwell software package licence to be plugged in.

